

NOVOKIT® NOTICE DE MONTAGE

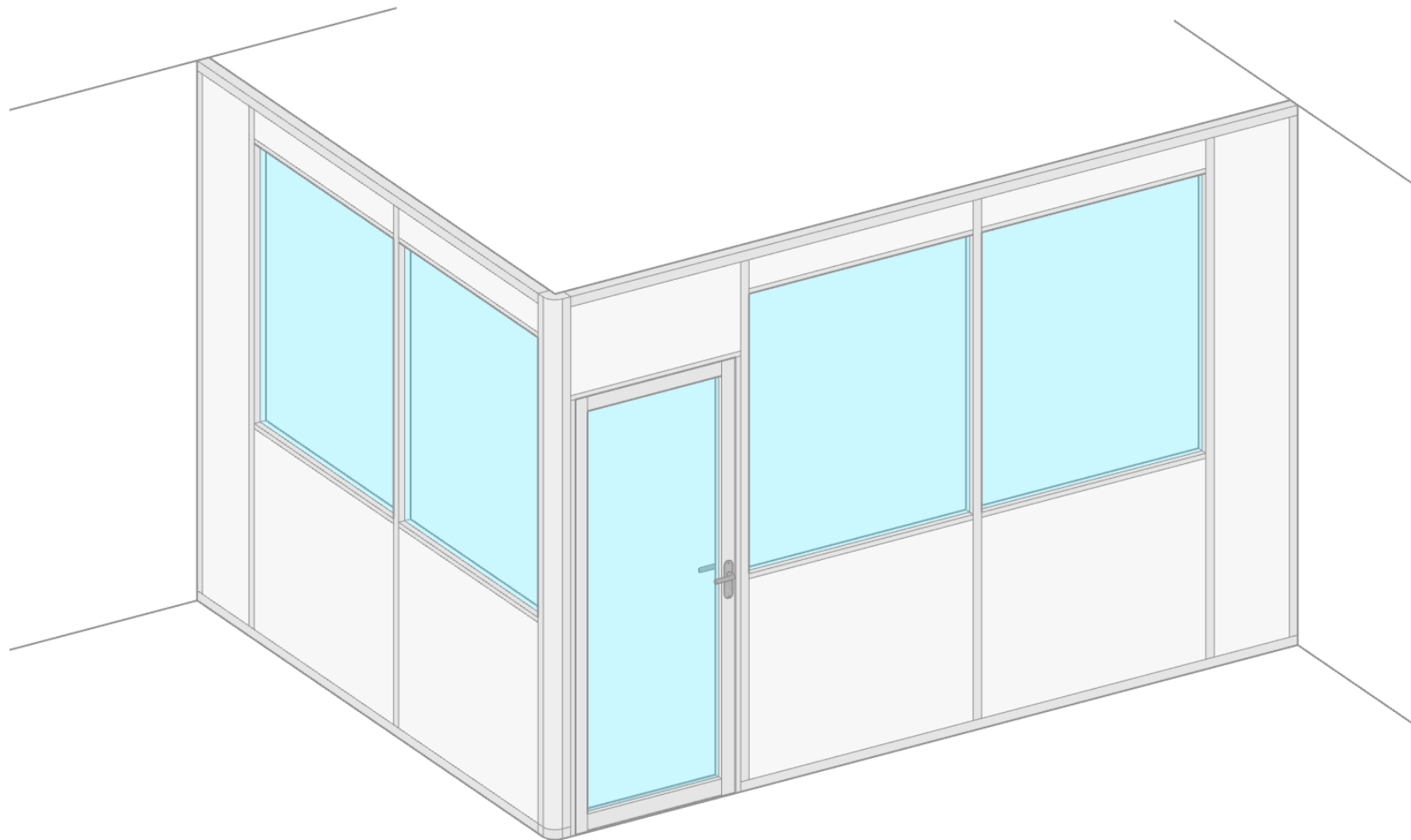

CLOISON DE BUREAU EN KIT

ETAPE 1 : fixation des rails et angle

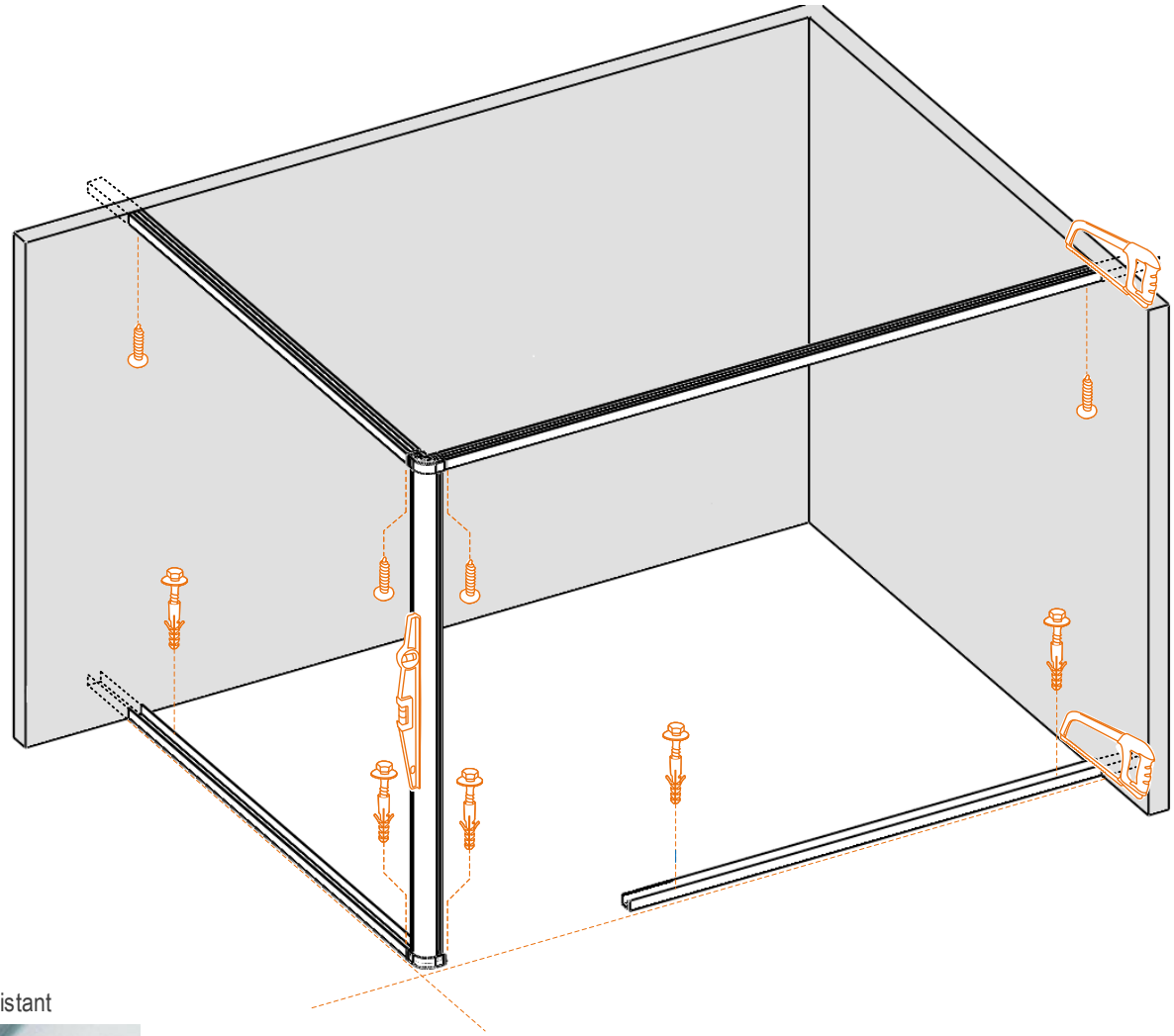
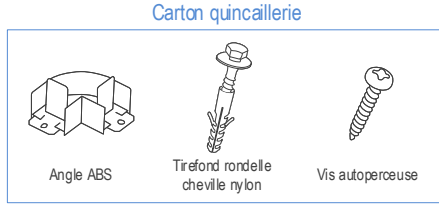
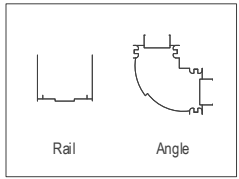
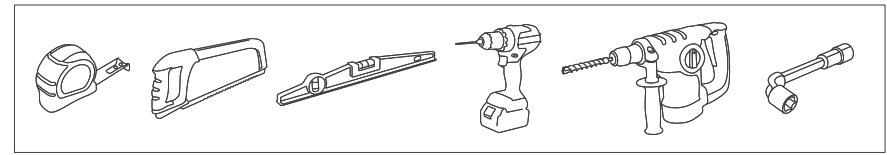

Fixation au sol du rail ALU



Fixation sous plafond existant



ETAPE 2 : mise en place et fixation des montants

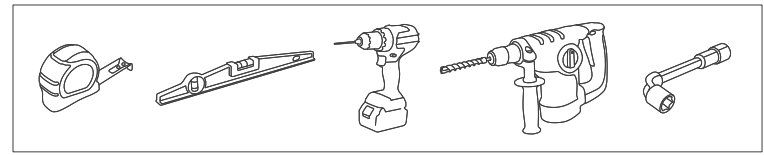

Carton quincaillerie

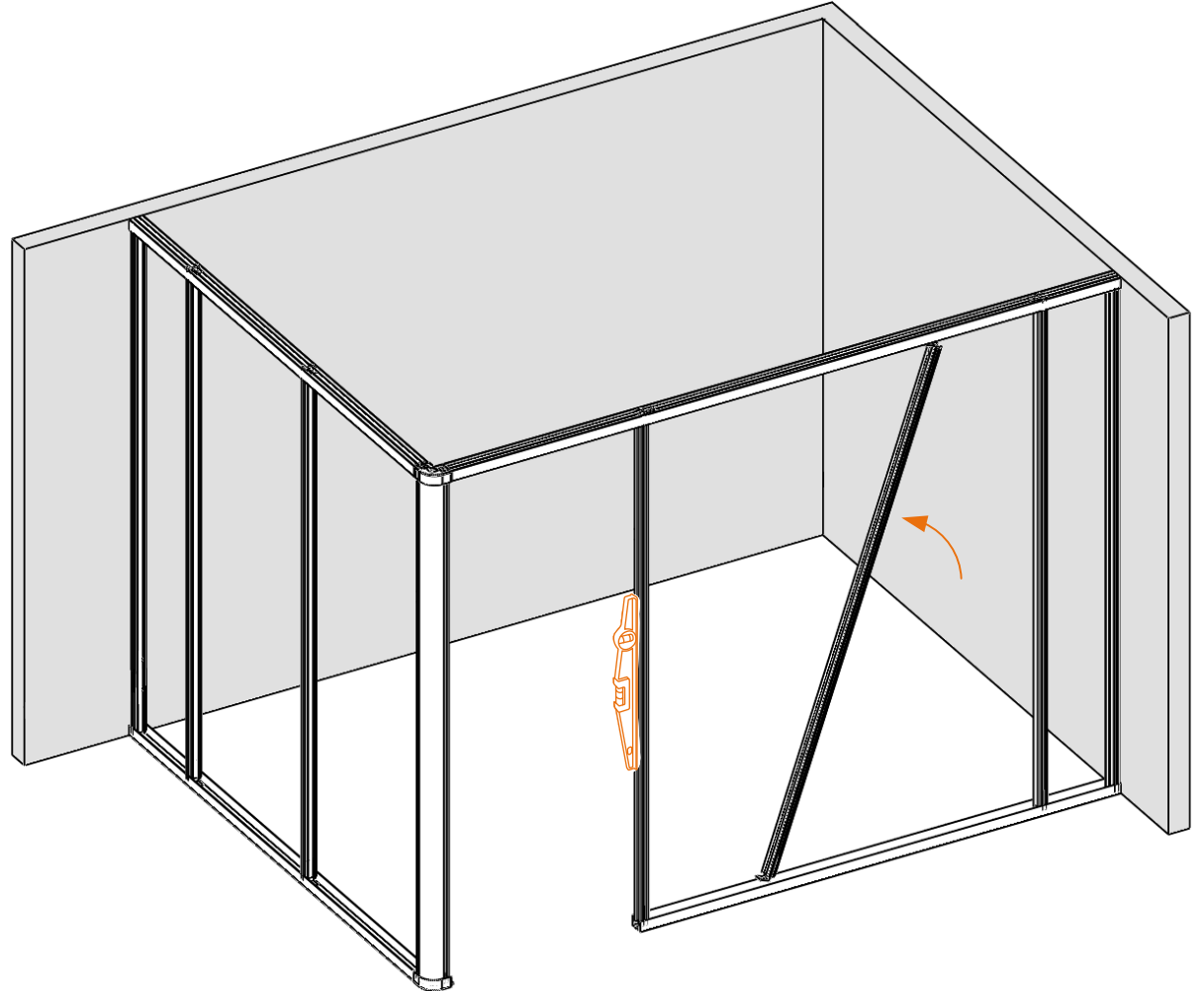
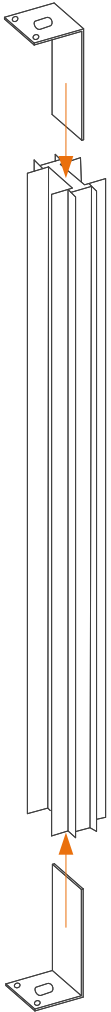
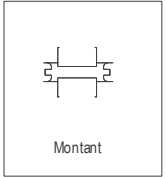

- glisser une équerre à chaque extrémité du montant
- positionner les montants dans les rails et vérifier l'aplomb
- fixer les équerres dans les rails bas et hauts

ETAPE 3 : mise en place des traverses et des plaques mélaminé

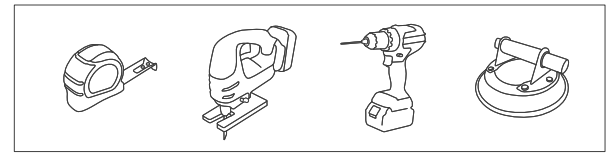

Carton quincaillerie

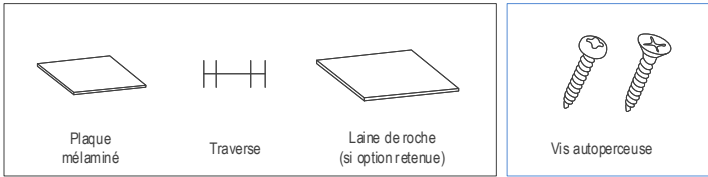

- visser les traverses basses et hautes
- visser les plaque mélaminé
- recouper les embouts pleins
- avec la ventouse, remonter les embouts pleins, maintenir et visser dans les montants

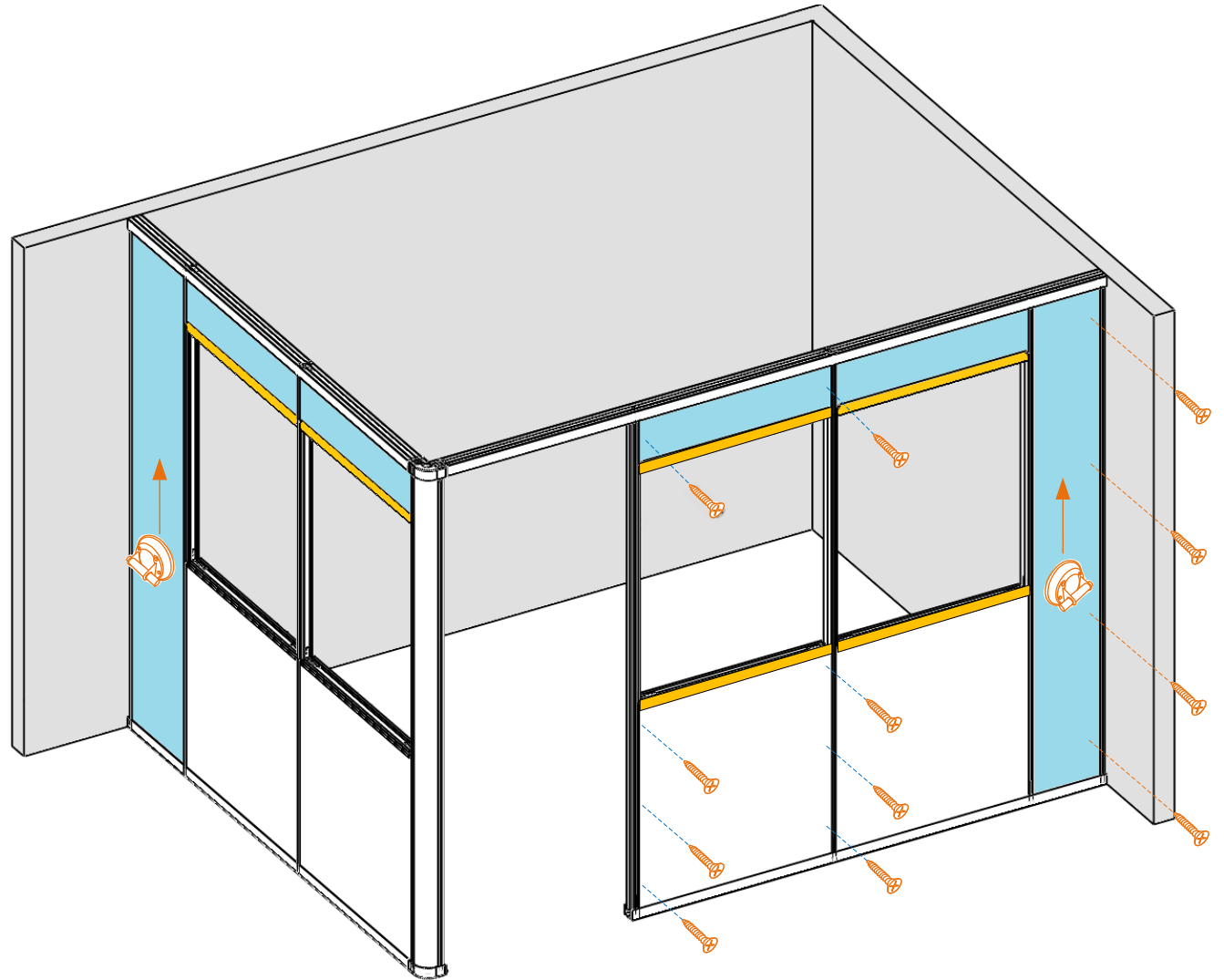
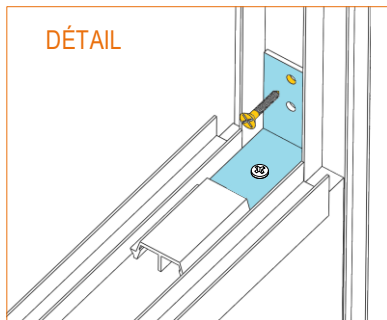

ETAPE 4 : Mise en place cache angle arrondi, enjoliveur et porte

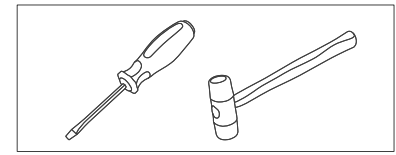

Carton quincaillerie

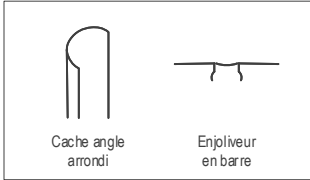

- accrocher la porte, visser le rive-bloc et le cylindre
- positionner le cache angle arrondi
- clipper les enjoliveurs

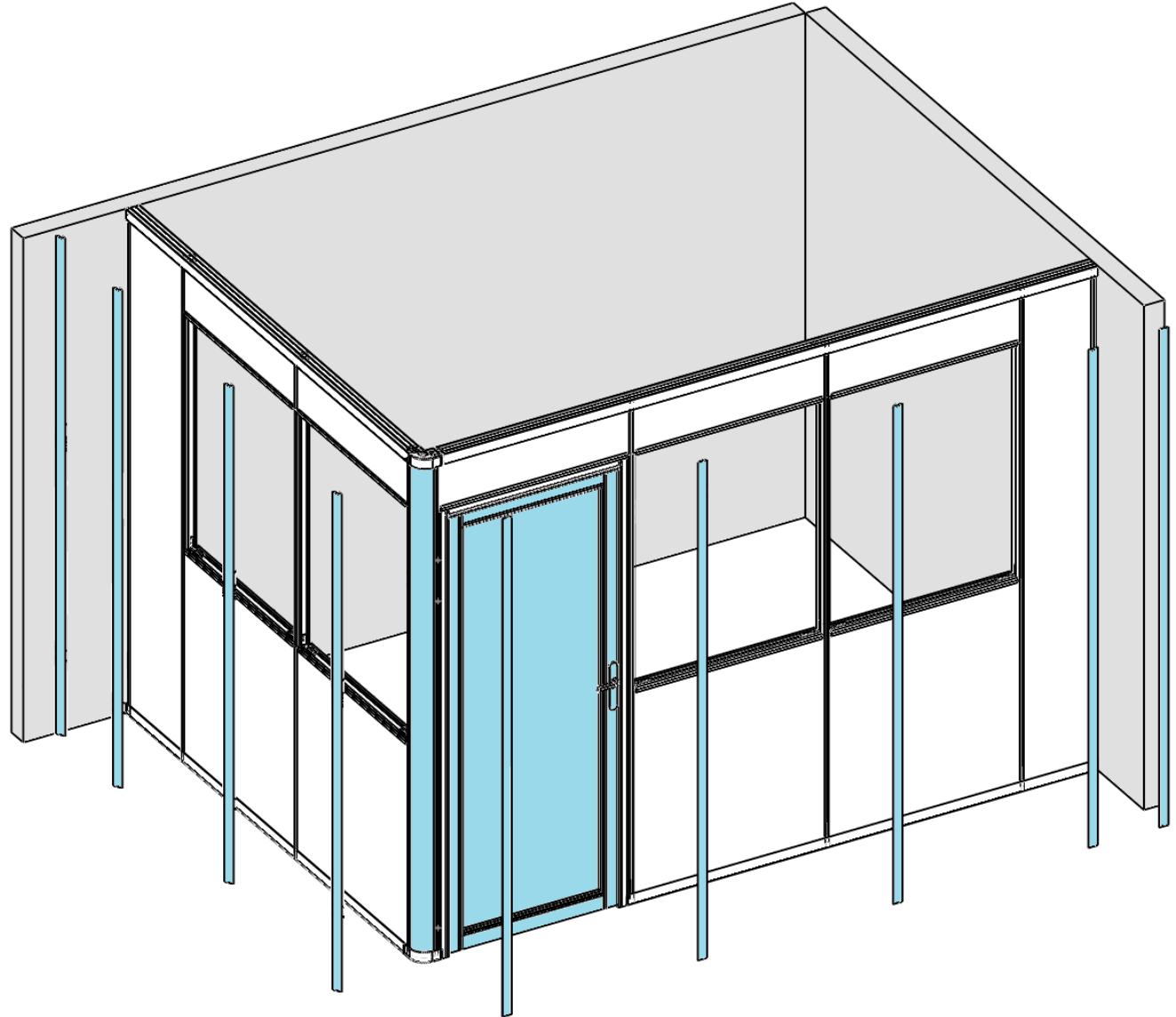

ETAPE 5 : Mise en place de la vitrerie

Carton quincaillerie

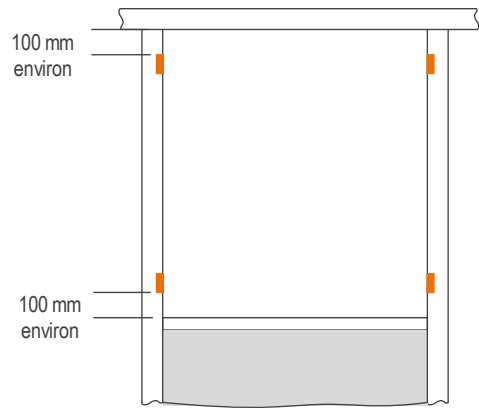
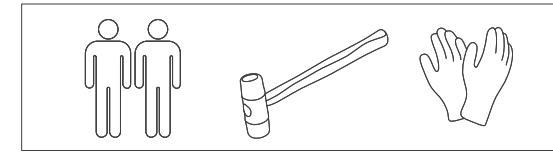
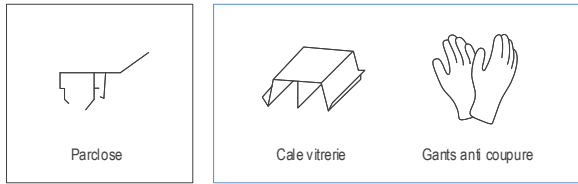

A) clipper 4 cales par vitre dans les montants à environ 100 mm du haut et du bas



B) clipper 2 parcloses horizontales (1 haute, 1 basse) sur un côté.

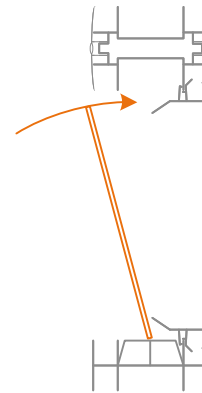

C) mettre la vitre en place, utiliser les gants anti coupure

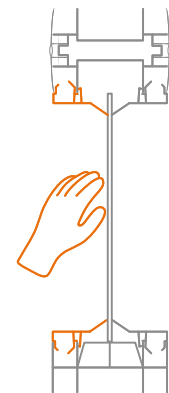

D) maintenir la vitre en place
- clipper les parcloses horizontales restantes
- finir par les parcloses verticales